



Dimensiuni compacte

Datorita unei constructii complete din tabla, unitatile sunt foarte compacte. Carcasa din tabla fara cadru nu are poduri reci si are un interior foarte usor de curatat. Toate componentele sunt demontabile.

Pierderi de presiune interne scazute

Toate suprafetele componentelor parcurse de debitul de aer realizeaza in ciuda dimensiunilor compacte, o pierdere de presiune internă redusa.

Motoare

Ventilatoarele sunt cu tensiune reglabila la 230V.

- unitate cu recuperarea caldurii cu schimbator in placi cu curent incrucisat
- bypass pentru dezghetarea schimbatorului in placi
- carcasa fara cadru, tabla zincata 1 mm
- 2 filtre panel F5
- ventilator cu palete orientate inainte
- motoare cu tensiune reglabila 230 V



Suprafete active mari

Filtrele, clapetele si recuperatorul sunt construite fara cadru. Urmarile sunt pierderi de presiune reduse si economisirea energiei.



Usor de curatat

Suprafata plata de la interior faciliteaza curatirea.



Carcasa de calitate

Carcasa este izolata cu 40 mm izolatie. (Unitate pentru montaj in tavan 30 mm)

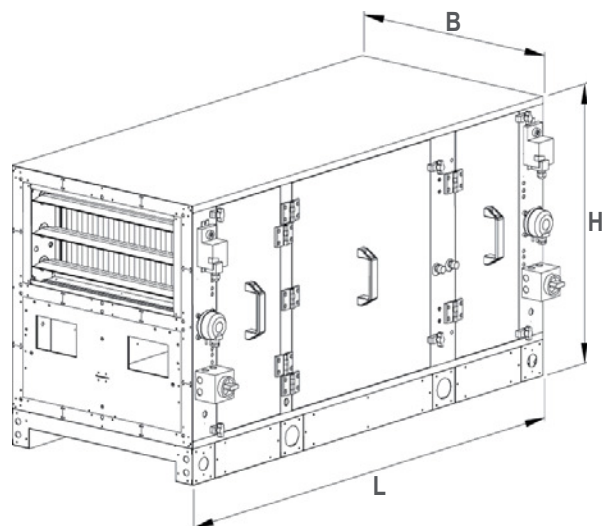



tip	ID	cu automatizare	Debit de aer la 200 Pa extern	Clapeta	filtru F5	Recuperator in placi	Baterie de incalzire cu apa calda	Baterie de racire cu apa rece	Baterie de racire in detenta directa	Motor cu tensiune reglabila	Motor pentru convertor de frecventa la 230V	L [mm]	B [mm]	H [mm]	L1 [mm]	greutate			
FG 6030 B10 33	113746	optional	1900	x	x	x	x		optional	x	optional	1578	690	845	2078	210			
FG 6030 B10 50	113747		2100	x	x	x	x			x		1578	690	845	2078	210			
FG 9030 B10 33	113758		2600	x	x	x	x			x		1578	990	845	2078	265			
FG 9030 B10 50	113759		2800	x	x	x	x			x		1578	990	845	2078	265			
FG 6030 B11 33	113749		1800	x	x	x	x	x				x	1958	690	845	2458	245		
FG 6030 B11 50	113750		2000	x	x	x	x	x				x	1958	690	845	2458	245		
FG 9030 B11 33	113760		2500	x	x	x	x	x				x	1958	990	845	2458	315		
FG 9030 B11 50	113761		2700	x	x	x	x	x				x	1958	990	845	2458	315		
FG 6030 B20 21	113752		1600	x	x	x	x					x	1477	1327	367	1977	205		
FG 6030 B20 24	113753		1750	x	x	x	x					x	1477	1327	367	1977	205		

legenda

- WW= Apa calda
- KW = apa rece
- DV = detenta directa
- L1 = include difuzor



accesorii individuale
Vezi detalii: 80

-  **TEM** ... transformator in 5 trepte fara protectie motor
-  **TES** ... transformator 7 trepte fara protectie motor
-  **GS** ... comutator

PWT 3,3	EUR	PWT 5,0	EUR	PWT 3,3	EUR	PWT 5,0	EUR	
FG 6030 B10 33 ID 113746	5250,-	FG 6030 B10 50 ID 113747	5050,-	FG 9030 B10 33 ID 113758	6100,-	FG 9030 B10 50 ID 113759	5900,-	
230V ~/50Hz 40 °C 2300 m³/h 930 W 6,3 A		230V ~/50Hz 40 °C 2450 m³/h 930 W 6,3 A		230V ~/50Hz 40 °C 3150 m³/h 1.500 W 9,5 A		230V ~/50Hz 40 °C 3320 m³/h 1.500 W 9,5 A		
TEM 075 ID 103507 265,- TES 075 ID 103957 146,- GS 01 ID 102787 56,-		TEM 075 ID 103507 265,- TES 075 ID 103957 146,- GS 01 ID 102787 56,-		TEM 100 ID 103511 420,- TES 100 ID 103958 140,- GS 01 ID 102787 56,-		TEM 100 ID 103511 420,- TES 100 ID 103958 140,- GS 01 ID 102787 56,-		

-  **SDK 9030** atenuator zgomot
-  **MAN 01** presostat diferential 50-500 Pa
-  **MAN 10** manometru cu tub inclinat
-  **THE 02** termostat antiinghet
-  **STA 01** actuator pentru clapete 24V, reglaj 3 puncte
-  **STA 11** actuator pentru clapete 230V, reglaj 3 puncte
-  **STA 02** actuator pentru clapete 24V, reglaj continuuu 0-10V
-  **STA 12** actuator pentru clapete 230V, reglaj continuuu 0-10V
-  **LFP 11 F5** filtru de rezerva
-  **LFP 11 F7** filtru de rezerva

SDK 9030 ID 109181	180,-	SDK 6030 ID 104057	170,-	SDK 9030 ID 109181	180,-	SDK 9030 ID 109181	180,-	
MAN 01 ID 104226	56,-	MAN 01 ID 104226	56,-	MAN 01 ID 104226	56,-	MAN 01 ID 104226	56,-	
MAN 10 ID 103587	104,-	MAN 10 ID 103587	104,-	MAN 10 ID 103587	104,-	MAN 10 ID 103587	104,-	
THE 02 ID 115566	139,-	THE 02 ID 115566	139,-	THE 02 ID 115566	139,-	THE 02 ID 115566	139,-	
STA 01 ID 103590	162,-	STA 01 ID 103590	162,-	STA 01 ID 103590	162,-	STA 01 ID 103590	162,-	
STA 11 ID 103933	160,-	STA 11 ID 103933	160,-	STA 11 ID 103933	160,-	STA 11 ID 103933	160,-	
STA 02 ID 107204	240,-	STA 02 ID 107204	240,-	STA 02 ID 107204	240,-	STA 02 ID 107204	240,-	
STA 12 ID 107631	280,-	STA 12 ID 107631	280,-	STA 12 ID 107631	280,-	STA 12 ID 107631	280,-	
LFP 11 F5 ID 108378	61,-	LFP 11 F5 ID 108378	61,-	LFP 20 F5 ID 108380	102,-	LFP 20 F5 ID 108380	102,-	
LFP 11 F7 ID 108673	64,-	LFP 11 F7 ID 108673	64,-	LFP 20 F7 ID 108379	104,-	LFP 20 F7 ID 108379	104,-	

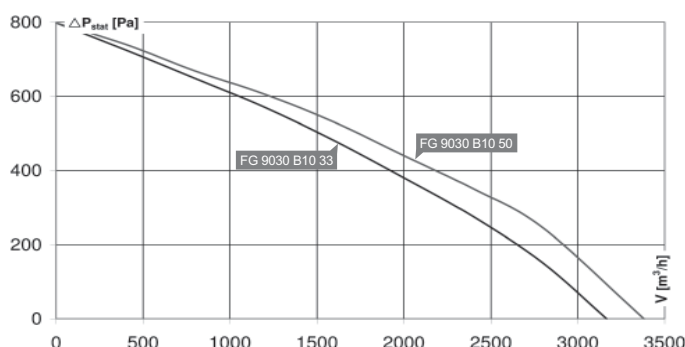
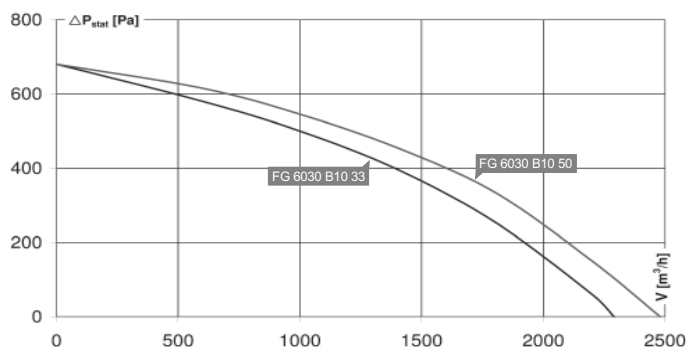

	PWT 3,3	EUR	PWT 5,0	EUR	PWT 3,3	EUR	PWT 5,0	EUR
	FG 6030 B11 33 ID 113749	5950,-	FG 6030 B11 50 ID 113750	5800,-	FG 9030 B11 33 ID 113760	7000,-	FG 9030 B11 50 ID 113761	6900,-
MYLW	230V ~/50Hz 40 °C 2250 m³/h 930 W 6,3 A		230V ~/50Hz 40 °C 2400 m³/h 930 W 6,3 A		230V ~/50Hz 40 °C 3050 m³/h 1.500 W 9,5 A		230V ~/50Hz 40 °C 3270 m³/h 1.500 W 9,5 A	
	TEM 075 ID 103507 265,- TES 075 ID 103957 146,- GS 01 ID 102787 56,-		TEM 075 ID 103507 265,- TES 075 ID 103957 146,- GS 01 ID 102787 56,-		TEM 100 ID 103511 420,- TES 100 ID 103958 140,- GS 01 ID 102787 56,-		TEM 100 ID 103511 420,- TES 100 ID 103958 140,- GS 01 ID 102787 56,-	



accesorii individuale
Vezi detalii: 80

TEM ...
transformator in 5 trepte
fara protectie motor



TES ...
transformator 7 trepte
fara protectie motor



GS ...
comutator



MYMZD	SDK 6030 ID 104057	170,-	SDK 6030 ID 104057	170,-	SDK 9030 ID 109181	180,-	SDK 9030 ID 109181	180,-	atenuator zgomot	
MYSLM	MAN 01 ID 104226	56,-	MAN 01 ID 104226	56,-	MAN 01 ID 104226	56,-	MAN 01 ID 104226	56,-	presostat diferential 50-500 Pa	
MYSLM	MAN 10 ID 103587	104,-	MAN 10 ID 103587	104,-	MAN 10 ID 103587	104,-	MAN 10 ID 103587	104,-	manometru cu tub inclinat	
MYSLT	THE 02 ID 115566	139,-	THE 02 ID 115566	139,-	THE 02 ID 115566	139,-	THE 02 ID 115566	139,-	termostat antiinghet	
MYSLS	STA 01 ID 103590	162,-	STA 01 ID 103590	162,-	STA 01 ID 103590	162,-	STA 01 ID 103590	162,-	actuator pentru clapete 24V, reglaj 3 puncte	
MYSLS	STA 11 ID 103933	160,-	STA 11 ID 103933	160,-	STA 11 ID 103933	160,-	STA 11 ID 103933	160,-	actuator pentru clapete 230V, reglaj 3 puncte	
MYSLS	STA 02 ID 107204	240,-	STA 02 ID 107204	240,-	STA 02 ID 107204	240,-	STA 02 ID 107204	240,-	actuator pentru clapete 24V, reglaj continuuu 0-10V	
MYSLS	STA 12 ID 107631	280,-	STA 12 ID 107631	280,-	STA 12 ID 107631	280,-	STA 12 ID 107631	280,-	actuator pentru clapete 230V, reglaj continuu 0-10V	
MYMEP	LFP 11 F5 ID 108378	61,-	LFP 11 F5 ID 108378	61,-	LFP 20 F5 ID 108380	102,-	LFP 20 F5 ID 108380	102,-	filtru de rezerva	
MYMEP	LFP 11 F7 ID 108673	64,-	LFP 11 F7 ID 108673	64,-	LFP 20 F7 ID 108379	104,-	LFP 20 F7 ID 108379	104,-	filtru de rezerva	

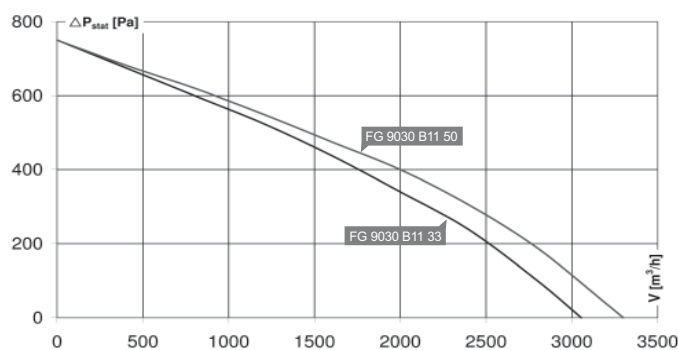
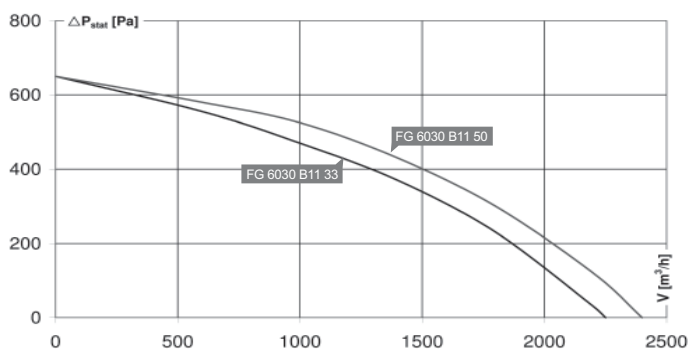

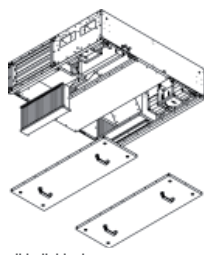

accesorii individuale
Vezi detalii: 80



TEM . . . transformator in 5 trepte fara protectie motor



TES . . . transformator 7 trepte fara protectie motor



GS . . . comutator



atenuator zgomot



presostat diferential 50-500 Pa



manometru cu tub inclinat

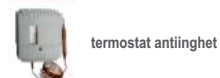

termostat antiinghet



actuator pentru clapete 24V, reglaj 3 puncte



actuator pentru clapete 230V, reglaj 3 puncte



actuator pentru clapete 24V, reglaj continuu 0-10V



actuator pentru clapete 230V, reglaj continuu 0-10V



filtru de rezerva



filtru de rezerva

PWT 2,1	EUR	PWT 2,4	EUR				
FG 6030 B20 21 ID 113752	4900,-	FG 6030 B20 24 ID 113753	4800,-				
230V ~/50Hz 40 °C 1970 m³/h 930 W 6,3 A		230V ~/50Hz 40 °C 2250 m³/h 930 W 6,3 A					
TEM 075 ID 103507 265,- TES 075 ID 103957 146,- GS 01 ID 102787 56,-		TEM 075 ID 103507 265,- TES 075 ID 103957 146,- GS 01 ID 102787 56,-					

SDK 6030 ID 104057	170,-	SDK 6030 ID 104057	170,-				
MAN 01 ID 104226	56,-	MAN 01 ID 104226	56,-				
MAN 10 ID 103587	104,-	MAN 10 ID 103587	104,-				
THE 02 ID 115566	139,-	THE 02 ID 115566	139,-				
STA 01 ID 103590	162,-	STA 01 ID 103590	162,-				
STA 11 ID 103933	160,-	STA 11 ID 103933	160,-				
STA 02 ID 107204	240,-	STA 02 ID 107204	240,-				
STA 12 ID 107631	280,-	STA 12 ID 107631	280,-				
LFP 11 F5 ID 108378	61,-	LFP 11 F5 ID 108378	61,-				
LFP 11 F7 ID 108673	64,-	LFP 11 F7 ID 108673	64,-				

